

# **Operating Manual**

## **Power X Pro Spot Extractor**



**MA51**

**Power X Pro Spot  
Extractor**



**MA51H**

**Power X Pro Spot  
Extractor with Heat**

Hydro-Force  
4282 South 590 West  
Salt Lake City, UT 84123  
801-268-2673  
801-268-3856 FAX

Revised: 10-08-2014

Power X Pro Spot Extractor Operating Manual  
**TABLE OF CONTENTS**

<u>TOPIC</u>	<u>PAGE #</u>
• Introduction	3
• Technical Specifications	4
<b><u>SECTION 1: Operational Safety</u></b>	
• Electrical Safety	5
• Mechanical Safety	6
<b><u>SECTION 2: Operation Procedures</u></b>	
• Electrical Supply	7
• Water Supply & Chemicals	7
• Solution & Vacuum Hoses	7
• Starting System - Switches	8
• Shutdown Procedures	9
• Troubleshooting	10-11
• Solution Flow Path MA51	12
• Solution Flow Path MA51H	13
• Wiring Diagrams MA51	14
• Wiring Diagrams MA51H	16
<b><u>SECTION 3: Maintenance/ Technical</u></b>	
• Maintenance	18
• Parts	21
○ MA51	22
○ MA51H	27
○ Hoses & Tool	34
• Warranty	35

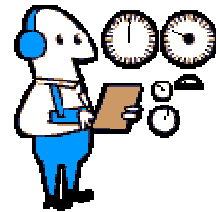

# Introduction

Congratulations on your purchase of the Hydro-Force Power X Pro Spot Extractor. The Power X Pro Spot Extractor is designed to combine versatility with ease of transport. Years of experience, engineering, and planning have gone into the design and manufacturing of the Power X Pro Spot Extractor. We take a great deal of pride in the Power X Pro Spot Extractor; our goal is no less than your complete satisfaction.

This manual will provide users with the knowledge required to operate the Power X Pro Spot Extractor safely, to understand how to properly operate and maintain the machine, and to ensure that the equipment operates at its maximum performance level.

**All users must read and understand this manual completely before operating the machine.**

Always maintain this manual in legible condition adjacent to the Power X Pro Spot Extractor, or place in a secure location for future reference.

Any questions pertaining to the operating or servicing of this unit should be directed to your nearest Hydro-Force distributor.

This manual is written specifically for the Power X Pro Spot Extractor units manufactured by:

Hydro-Force  
4282 South 590 West  
Salt Lake City, UT 84123  
801-268-2673  
801-268-3856 FAX

Information in this manual is subject to change without notice and does not represent a commitment on the part of Hydro-Force or its parent or affiliated companies.

# Technical Specifications

## Power X Pro Spot Extractor Model MA51

Height:	19"
Length:	21"
Width:	10"
Weight:	18lbs.
Solution Tank Capacity:	3 gallon
Recovery Tank Capacity:	3 gallon
Power Cord:	20 foot – 16/3
Solution Outlet	1/4" Male Quick Connect
Solution Pump:	Flojet ET508224-HP pump 55 psi – 0.37gpm
Vacuum Motor:	AMETEK Lamb 4.8" Diameter – Peripheral discharge Two Stage 87.7cfm – 76.5" WC
Power Draw:	6.42 / 7.3 amps

## Power X Pro Spot Extractor with Heater Model MA51H

Height:	24"
Length:	21"
Width:	10"
Weight:	30lbs.
Solution Tank Capacity:	3 gallon
Recovery Tank Capacity:	3 gallon
Power Cord:	20 foot 16/3
Solution Outlet	1/4" Male Quick Connect
Solution Pump:	Flojet ET508224-HP pump 55 psi – 0.37gpm
Vacuum Motor:	AMETEK Lamb 4.8" Diameter – Peripheral discharge Two Stage 87.7cfm – 76.5" WC
Heater:	600 Watt
Power Draw:	11.7 / 12.3 amps

## Standard Equipment

Tool:	PA205 - Stainless Steel 3.5" Detail Tool
Vacuum Hose:	7' X 1-1/4" with 1-1/2" cuffs
HP Solution Hose:	8' x 3/16" with 1/4" female quick connect

## Safety

**CAUTION!** This machine is an electrical appliance. Care must be taken to reduce the risk of electrical shock.

- **READ AND UNDERSTAND ALL INSTRUCTIONS BEFORE OPERATING THE POWER X PRO SPOT EXTRACTOR.**
- To reduce the risk of property damage or injury, repairs to electrical systems should only be performed by experienced technicians. Contact your distributor for assistance. Unplug machine power cord from outlet before performing any repairs on the extractor.
- This machine shall be grounded while in use to protect the operator from electric shock. The machine is provided with a three-conductor cord and a three-contact grounding type attachment plug to fit the proper grounding type receptacle. The green (or green and yellow) conductor in the cord is the grounding wire. Never connect this wire to other than the grounding pin of the attachment plug.
- This machine is for use on a nominal 120-volt circuit and has a grounding plug that resembles the plug illustrated in the sketch to the right. Make sure that the machine is connected to an outlet having the same configuration as the plug. No plug adapter should be used with this machine.
- The power cord supplied with this machine is properly sized to handle the electrical load of this machine and properly grounded as described above. Any extension cords used with this machine must be similarly sized and grounded to assure safe operation. A properly sized GFCI protected cord can be used for additional protection.
- Do not use the POWER X PRO SPOT EXTRACTOR outdoors, in standing water or on wet surfaces. Do not store the POWER X PRO SPOT EXTRACTOR in wet conditions. If extractor is leaking, unplug machine power cords from outlets before approaching or touching machine.
- Do not unplug power cord by pulling on the cord. Grasp the plug end when unplugging the cord. Do not pull the extractor by the cord. If cord or plug is damaged, do not use cord. Replace with new cord or repair as needed before use.
- Overloaded circuit may not always trip circuit breaker. Reduced voltage to machine on overloaded circuit will prevent components from operating properly.

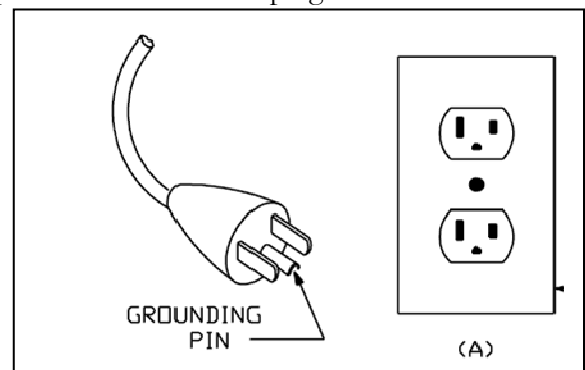

**WARNING!** This machine must be protected from conditions which may damage the pump, tank, hoses and other components.

- **Freezing of water in this machine will cause serious damage.** The POWER X PRO SPOT EXTRACTOR, solution hoses, and tools must be protected from freezing temperature. Store, transport, and use this equipment only in temperatures well above freezing. (32°F or 0°C). If you suspect the POWER X PRO SPOT EXTRACTOR has been frozen, do not plug in or turn on machine until you are sure it has thawed completely.
- If the equipment cannot be stored or transported in a warm environment, it can be guarded from freezing by running an anti-freeze solution through the incoming water lines, chemical feed system, solution pump, solution lines, tools and pump-out pump. The machine is filled at the factory with anti-freeze to eliminate damage during shipment in cold weather.
  - The anti-freeze solution must be completely flushed from the machine before it is returned to service.
- The POWER X PRO SPOT EXTRACTOR must not be used to pick up flammable or combustible materials or used in areas where these materials may be present.
- Solvent-based or water-based solutions containing solvents may damage the pump, hoses, and other components. Do not assume chemical compatibility. Contact your distributor or Hydro-Force if you have questions regarding the compatibility of your chemicals with the machine.
- Do not clean with solutions that are at temperatures above 100°F.
- Rinse the solution tank, chemical system, and pump with fresh water after each day's use.
- Do not allow pump to run dry. Always maintain adequate solution level to supply solution pump.
- Solution hoses may rupture if worn or damaged. Do not use solution hoses if hose covering is cut, bulging, or otherwise damaged. Examine solution hoses daily and replace or repair hoses as needed.
- Keep Vacuum Filter Cap clean and check float for proper operation. Do not operate the POWER X PRO SPOT EXTRACTOR without the Vacuum Filter Cap in place. **Use defoamer to eliminate foam build-up during cleaning and prevent foam/moisture from entering vacuum.**

**\*\*\*Use common sense to protect yourself and others while using this equipment.\*\*\***

- Keep pets and children away from the machine when in use.
- Keep all body parts, hair, and loose clothing away from openings and moving parts. Always wear appropriate clothing and safety equipment when operating unit.
- Use extra care when cleaning on stairs. Wet carpet on stairs can be slippery.
- Secure latch before moving. Lift using only the appropriate handle.
- Water may be spilled, drip, or be exhausted from vacuums during operation. Place unit in area where water will not cause damage or use drop cloth to protect surfaces.

## Operation Procedures

*Knowledge of the proper operation of the Power X Pro Spot Extractor is required to ensure user safety and efficient performance of the extractor.*

- ❖ Prior to using the Power X Pro Spot Extractor for the first time the Anti-Freeze used to protect the unit during shipping must be flushed from pump, hoses & tool. Pour one quart of clean water into the solution tank, connect cord, hoses & tool. Spray the tool into a bucket or sink to flush out the ant-freeze before using the Power X Pro Spot Extractor for cleaning.

## SET UP AND OPERATION

### 1. Electrical Cord:

Plug the power cord into the 120volt wall outlet. Make sure the circuit can handle the power load the operation of the Power X Pro Spot Extractor will place on the circuit.

### 2. Water Supply & Chemical Mixing– Manual Fill:

- Pour up to 3 gallons of hot water into the solution tank at the front of the machine. This will fill the tank to a level approximately 4 inches from the top of the tank.  
**The water temperature should not exceed 120°F.**
- Measure and add the appropriate amount of the desired liquid chemical to the water in the solution tank. The amount of chemical will vary depending on the type of chemical used, the amount of water in the tank, and the material being cleaned; consult the chemical packaging for specific mixture ratios.
- Powdered chemicals should be dissolved in water in a separate container before being added to the water in the solution tank.

### 3. Connection of Hose:

Connect the solution hose to the solution outlet male quick connect on the front of the machine. The other end of the hose should always be connected to the cleaning tool.

The Vacuum Hose is connected to the barb on the recovery tank of the Power X Pro Spot Extractor. The 1-1/2" cuff on the vacuum hose is simply pushed onto the barb. The 1-1/2" cuff on other end is connected to the cleaning tool. **Add defoamer to the recovery tank to prevent foam build-up in recovery tank during cleaning and to keep foam/moisture from entering vacuum.**

## **4. Starting the Spotter - Power Switches:**

### **MA51**

The new style MA51 without heat has two switches, one to turn on the vacuum motor & one to turn on the solution pump.

(Older Power X Pro Spot Extractors without heat only had one switch for both the vacuum and the pump.)

When you are ready to start cleaning, turn the switches to the ON position. For standard cleaning turn on both switches. For extraction only, you can turn on just the Vacuum Switch. The FloJet solution pump, standard on the Power X Pro Spot Extractor is self-priming and usually additional priming procedures are not required.

If the pump does not prime by itself, or if flow is low or unsteady, check the hose from the solution tank to the pump and the filter screen for clogging, kinks, or restrictions. Clean or replace hose and/or filter and. Turn switch ON. Check the valve operation and the jet on the tool for flow restriction that can affect solution flow.

If you are having trouble with the pump, refer to the trouble shooting guide or contact your distributor for advice or assistance.

### **MA51H**

The MA51H with heat has three switches one to turn on the vacuum motor, one for the solution pump & one for the heater.

When you are ready to start cleaning, you should first turn the vacuum switch to the ON position. If you are extracting only you do not need to turn on the solution pump switch or the heater switch.

If you will be spraying solution, turn the solution pump switch ON. The Flojet solution pump, standard on the Power X Pro Spot Extractor is self-priming and usually additional priming procedures are not required. If the pump does not prime by itself, or if flow is low or unsteady, check the hose from the solution tank to the pump and the filter screen for clogging, kinks, or restrictions. Clean or replace hose and/or filter and. Turn switch ON. Check the valve operation and the jet on the tool for flow restriction that can affect solution flow.

If you are having trouble with the pump, refer to the trouble shooting guide or contact your distributor for advice or assistance.

Once you have solution flow to the tool, you can turn the heater switch ON. Let the heater heat the solution for about five minutes before you start spraying. For the best heater performance and maximum heat output use the water slowly and take extra drying passes between spraying passes to give the water more time to heat up.

## **5. Spotter Operation:**

As you operate the spotter the water and soil you vacuum up will collect in the recovery tank. The Power X Pro Spot Extractor is equipped with a Float Shutoff assembly which will block the vacuum air flow when the tank is filled. The float rises with the water level in the recovery tank until it gets to the top, blocking the vacuum air flow. When this happens you will notice a change in the sound of the vacuum motor. This is your signal to turn off the unit and empty the recovery tank. Disconnect the hoses and drain the tank by pouring the water out of the vacuum barb. Do not attempt to drain the recovery tank from the hatch cover opening. Do not use the same bucket to drain the unit that you use to fill the solution tank. Add more defoamer to the recovery tank before you resume cleaning.

After draining the tank, before you place the recovery tank back onto the spotter base, check the water level in the solution tank and add more water and detergent as needed to complete your cleaning. Then place the recovery tank back onto the solution tank, reconnect the hoses and resume cleaning.



## Shutdown Procedures:

- ❖ (MA51H only) If you are using the heater turn the heater off before you make the last few cleaning passes or spray the tool into a bucket for a minute to cool off the heater, before you turn the pump switch off.
- ❖ When finished cleaning, turn off all switches.
- ❖ Disconnect the power cord from the outlet.
- ❖ Disconnect the solution hose and vacuum hose from the Power X Pro Spot Extractor. Pull valve trigger to release pressure from the hose before disconnecting solution hose.
- ❖ Drain any remaining water from the solution tank and the recovery tank and dispose in sanitary drain. Drain the recovery tank by pouring the water out of the vacuum barb. Do not attempt to pour the water out the recovery tank hatch cover opening. Do not use the same bucket to drain the tank that you use to fill the tank.
- ❖ Remove the float shutoff assembly from the recovery tank and clean filter & float as needed.
- ❖ Replace shutoff assembly and tank lid.
- ❖ Roll up power cord. Collect and store Power X Pro Spot Extractor, hoses, tool, and any other accessories.

# Troubleshooting

## Troubleshooting – Power X Pro Spot Extractor

Problem	Cause	Solution
Machine not turning on - No power	Building circuit breaker tripped.	Reset breaker or move cord to other outlet
	Faulty power cord	Replace cord
	Faulty switches or internal wiring	Check wiring & test switches - Repair as needed *
Solution Pump not running	Building circuit breaker tripped.	Reset breaker or move cord to other outlet.
	Faulty power cord	Replace cord
	Faulty switches or internal wiring	Check wiring & test switches - Repair as needed *
	Pump faulty	Replace Pump (AP30)
Low Solution Pressure and/or Pulsation	Jet too large for pressure desired	Check jet size & flow rates use smaller jets
	Jet worn allowing too much flow	Replace jet
	Solution inlet filter plugged	Clean or replace filter
	Hose from solution tank restricted	Repair or replace hose
	Heater Restricted with scale (MA51H Only)	De-scale or replace the heater
	Pressure Relief valve stuck open (MA51H Only)	Replace the pressure relief valve
	Pump intake hose or fittings leaking	Repair or replace hose. Tighten clamps or replace fittings
	Solution tank empty	Add water to tank - Check & repair auto fill assembly
	Pump faulty	Repair or replace pump (AP30)
	Tool valve faulty	Repair or replace valve
Can't connect solution hose to machine	Pressure in lines	Turn off pump - Release pressure
	Quick connects faulty	Replace quick connects (AH101B, AH102B)
	Wrong style/size quick connects	Replace quick connects to match connects on machine
Heater not Heating (MA51H Only)	Faulty switches or internal wiring	Check wiring & test switches - Repair as needed *
	Temperature Switch tripped	Reset manual reset temperature switch.
	Faulty temperature switches	Replace temperature switches on heater
	Faulty Heater	Replace heater
	Flow too high for proper heating	Use smaller jet or slow use of water
Water Starting out too cold	Heat water before filling tank – Maximum 120°F	
<p>* To reduce the risk of fire electrical shock or injury repairs to wiring should only be performed by experienced service technicians. If you are not experienced in checking electrical wiring contact your nearest authorized service center to perform tests and repairs to wiring and switches.</p>		

<b>Problem</b>	<b>Cause</b>	<b>Solution</b>
Vacuum Motor not running	Building circuit breaker tripped.	Reset breaker or move cord to other outlet
	Faulty power cord	Replace cord
	Faulty switch or internal wiring	Check wiring & test switch - Repair as needed *
	Vacuum motor faulty	Replace vacuum motor (AV06)
Loss of Vacuum	Vacuum motor faulty	Replace vacuum motor (AV06)
	Vacuum motor gasket damaged	Replace gasket (PS10-1030)
	Recovery tank lid gasket damaged	Replace lid assembly or gasket
	Vacuum hose or tool clogged	Clean out vacuum hoses and tool
	Vacuum hoses or cuffs leaking	Replace vacuum hoses, cuffs & connectors as needed
	Recovery tank full	Drain tank
	Float shutoff filter clogged	Clean float shutoff filter
	Float shutoff stuck	Repair or replace float shutoff
	Recovery tank damaged	Replace recovery tank
Tool won't spray - low or uneven spray	Jet clogged	Clean out or replace jet
	Inline filter clogged	Clean out or replace filter if so equipped
	Jet worn	Replace jet
	Jet not aligned properly	Re-align jet
	Tool valve faulty	Repair or replace valve
	Quick connects or hoses restricted	Clean out or replace quick connects and/or hoses
	Pump not pumping	See Troubleshooting sections relating to solution pump
<p>* To reduce the risk of fire electrical shock or injury repairs to wiring should only be performed by experienced service technicians. If you are not experienced in checking electrical wiring contact your nearest authorized service center to perform tests and repairs to wiring and switches.</p>		

- Contact your distributor for additional troubleshooting assistance, to order parts, or for advice and assistance in performing necessary repairs.

# MA51

## Solution Flow Path

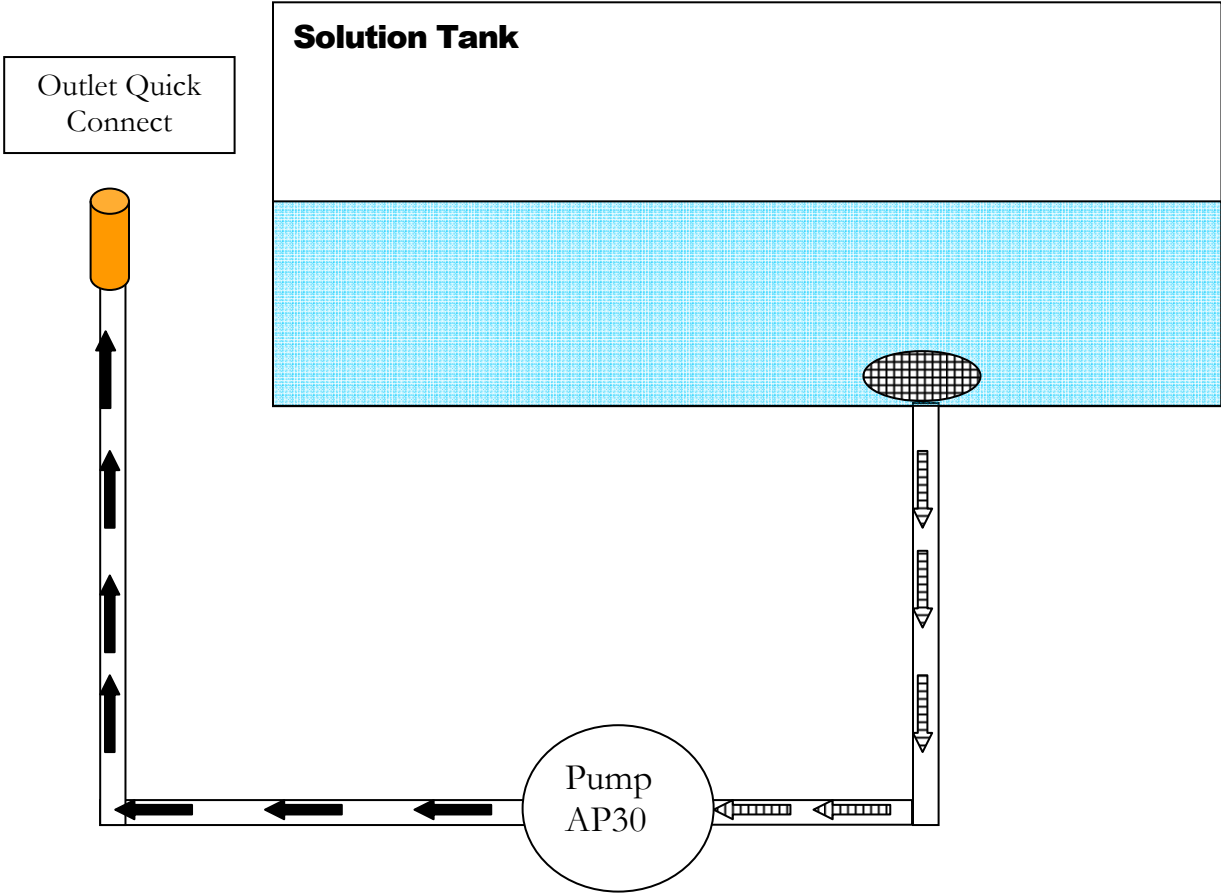

Denotes incoming water flow



Denotes Water flow in pressure hose



# MA51H

## Solution Flow Path

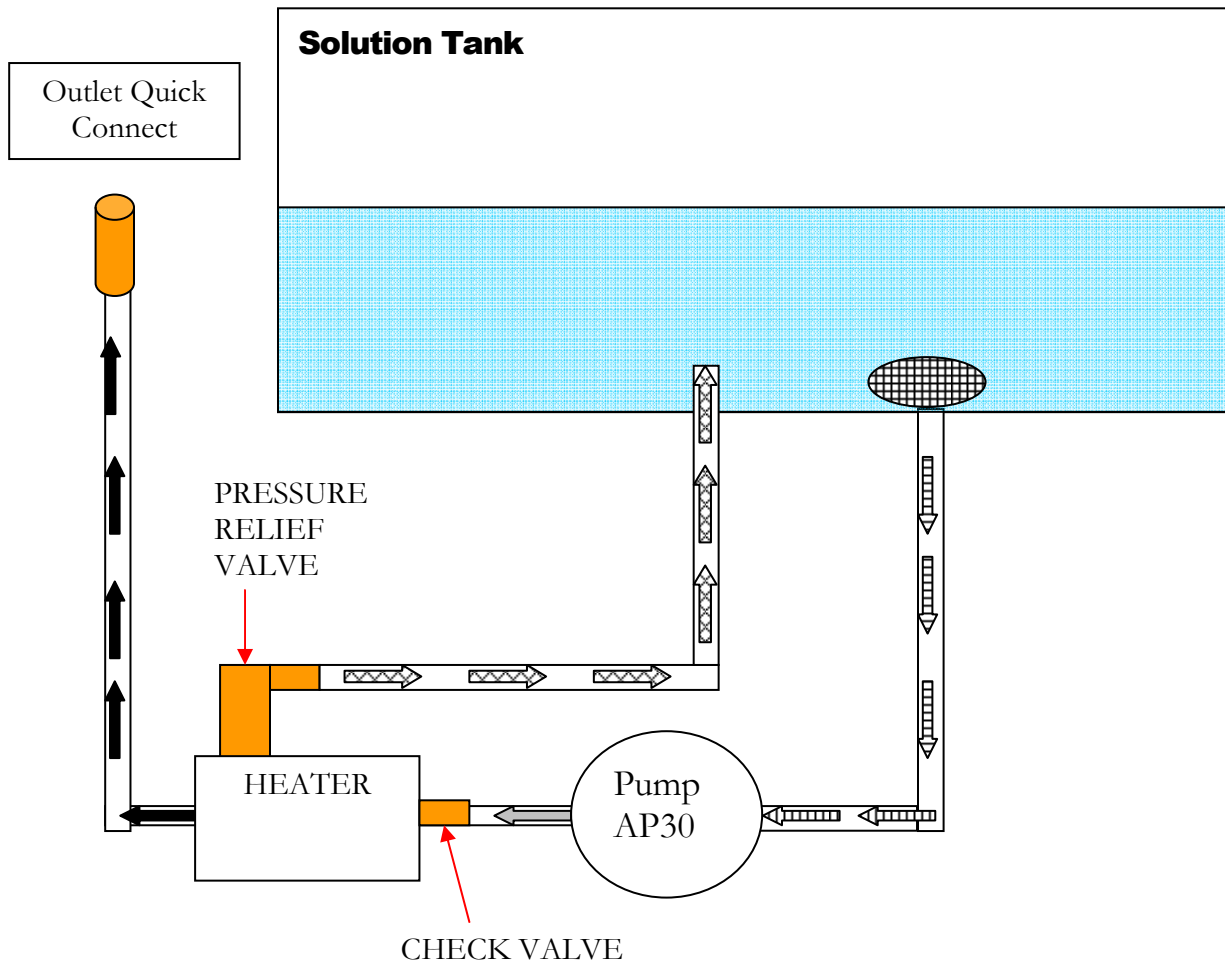

Denotes incoming water flow



Denotes Cold Water flow in pressure hose



Denotes Heated Water flow in pressure hose



Denotes Heated Water by-pass flow from heater pressure relief



# MA51 Wiring Diagram - Standard

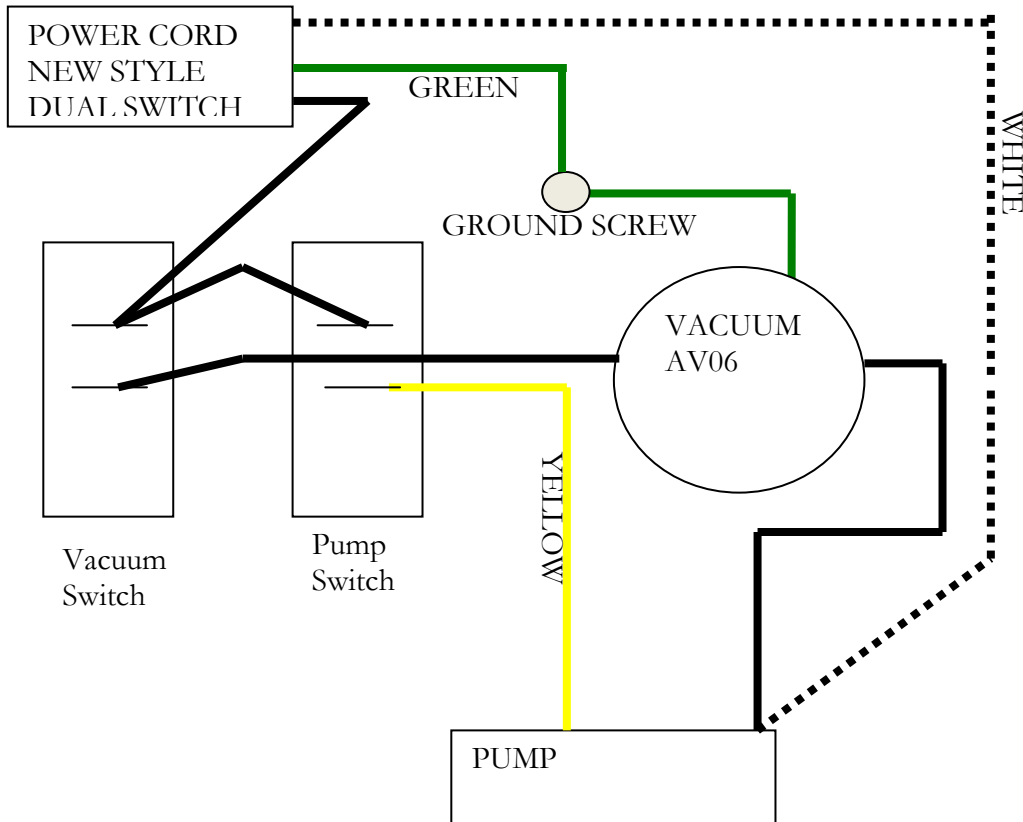
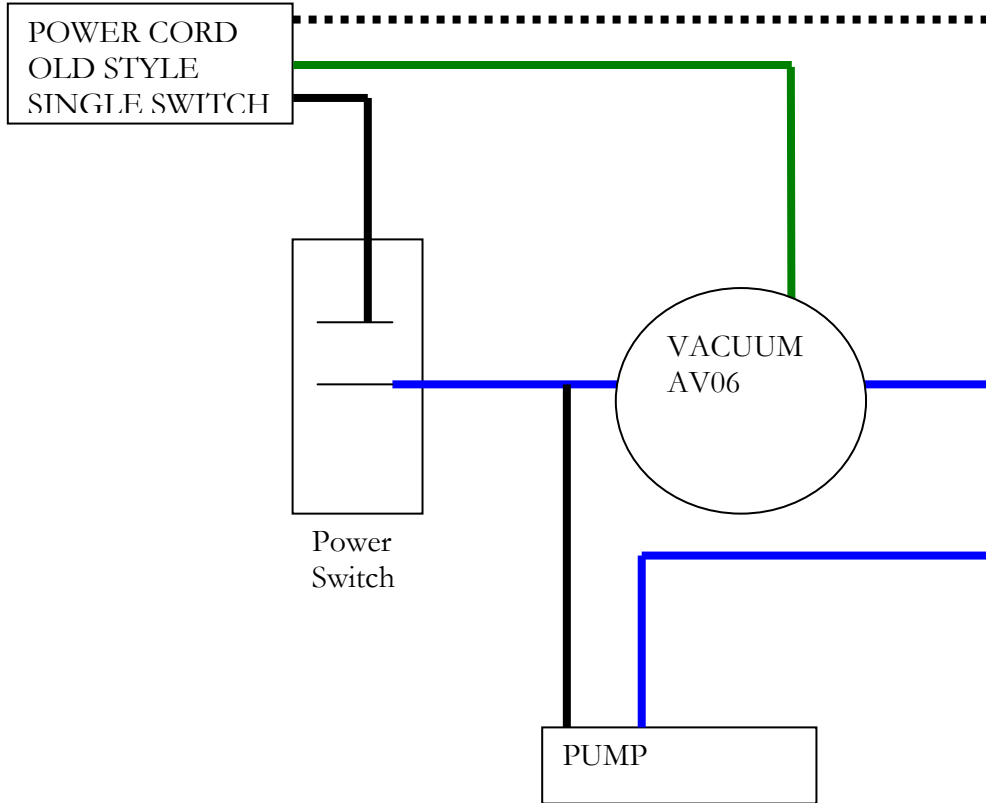

# MA51 STANDARD SWITCH PANEL:

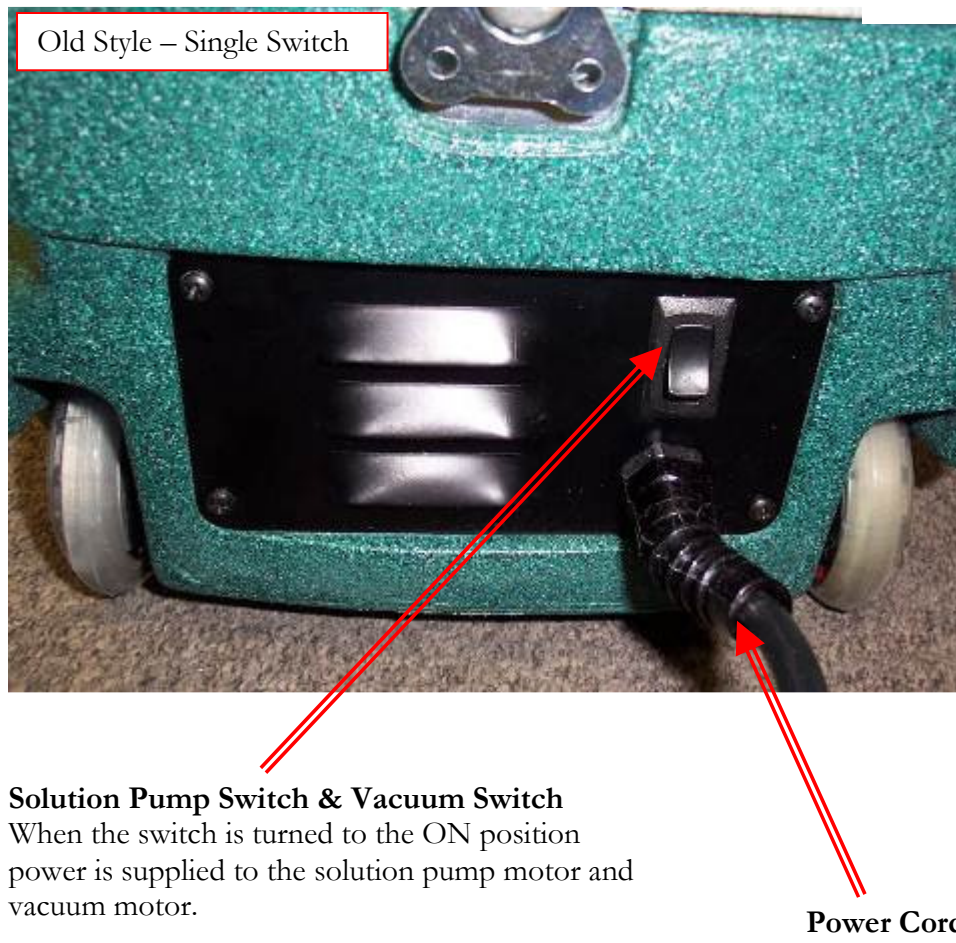
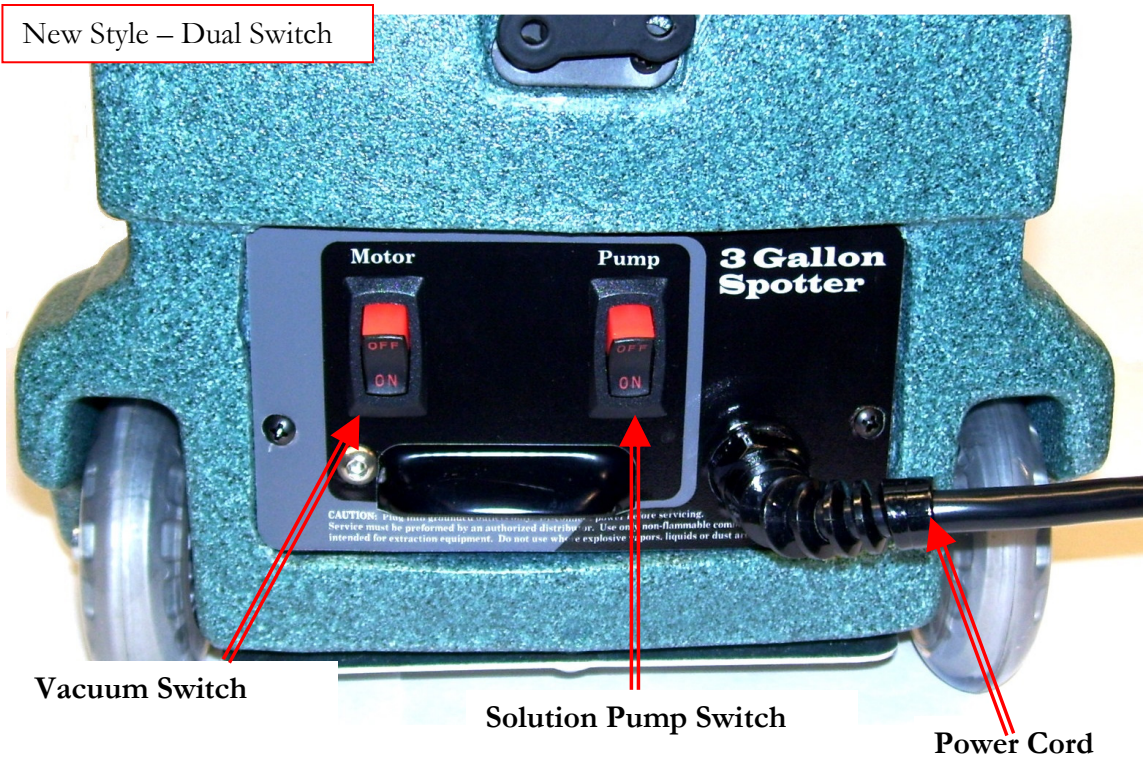

# MA51H

## Wiring Diagram with Heater

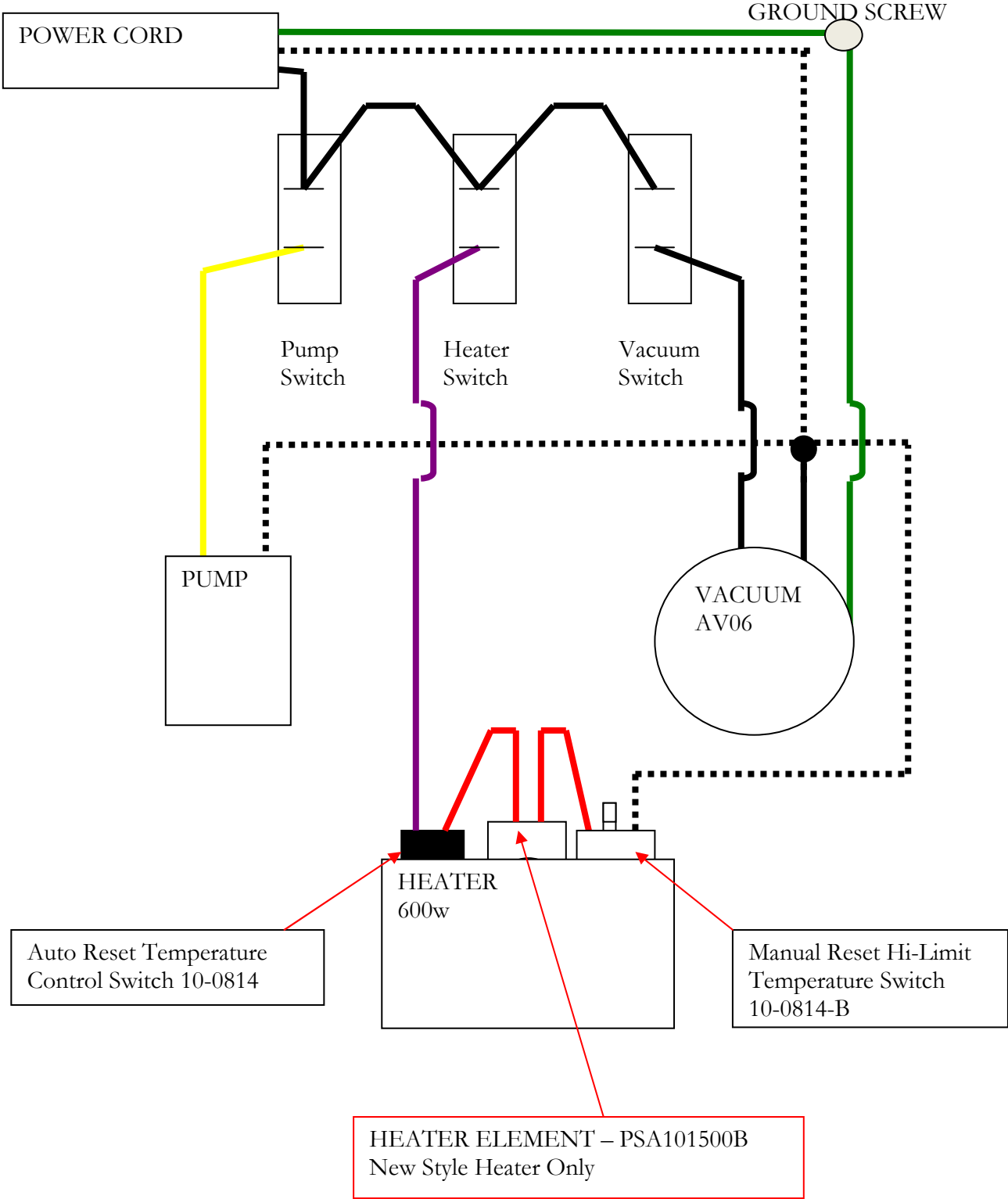



# MA51H with HEATER SWITCH PANEL:

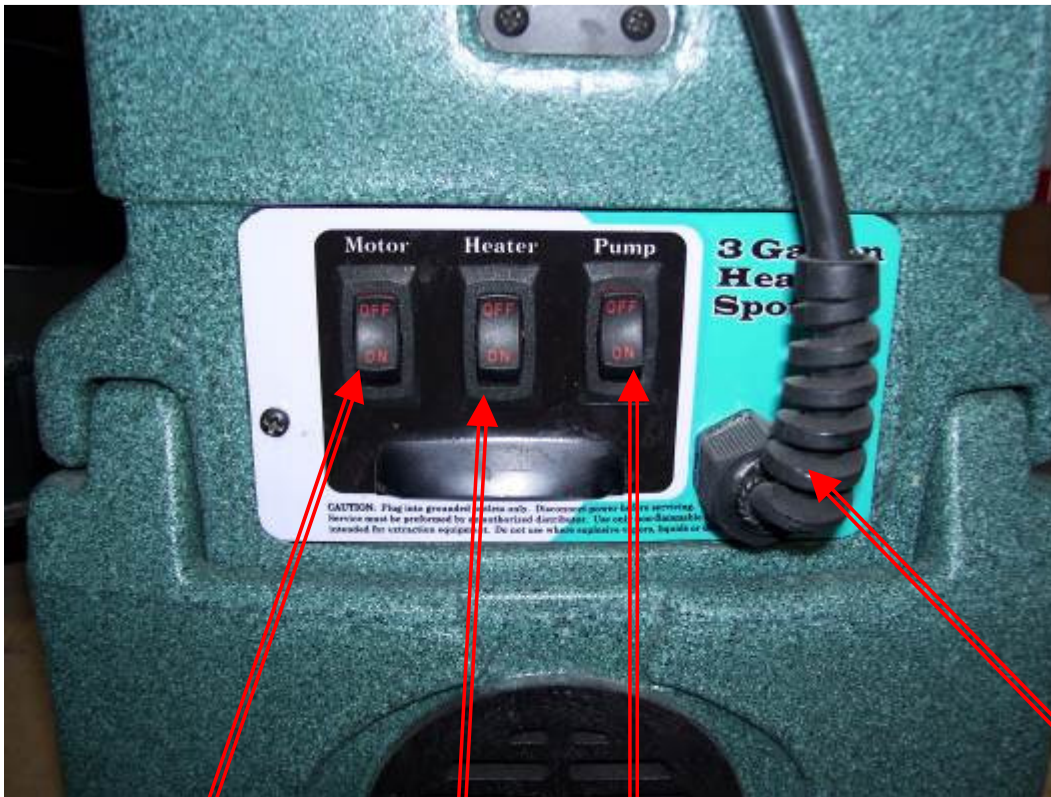

## Vacuum Switch

When the switch is turned to the ON position power is supplied to the vacuum motor only.

## Solution Pump Switch

When the switch is turned to the ON position power is supplied to the solution pump motor only.

When not using solution (Extracting only), do not turn this switch ON.

## Heater Switch

When the switch is turned to the ON position power is supplied to the solution heater only. Always turn pump switch on first and be sure water is flowing to the tool before turning heater ON.

Turn heater off and spray tool for a minute to cool off heater before turning pump off.

When not using solution (Extracting only), do not turn this switch ON.

## Power Cord

## Maintenance

*Proper maintenance is required to keep the Power X Pro Spot Extractor operating properly, prevent downtime and to extend the life of your equipment.*

**WARNING:** Disconnect electrical power before performing any service or maintenance inside machine base or before testing or repairing switches or power cords. Failure to do so may result in severe personal injury or death.

OPERATION	INTERVAL	Page #
CLEAN VACUUM SHUTOFF ASSEMBLY	Daily – After Each Job	19
RINSE OUT RECOVERY TANK	Daily	19
FLUSH SOLUTION TANK AND PUMP	Daily	19
CLEAN PUMP-INLET FILTER	Daily	19
DESCALING HEATER – MA51H ONLY	As needed	20
REMOVING BASE TO ACCESS HEATER – MA51H ONLY	As needed	20
STORAGE PREP – FREEZE PROTECTION	As needed	20

## **CLEAN VACUUM SHUTOFF ASSEMBLY:**

Inside the recovery tank, on top of the stand pipe, is the Vacuum Shutoff Assembly. It functions to prevent debris and water from being sucked into the vacuum motors. Operating the Power X Pro Spot Extractor without the Vacuum Shutoff Assembly or with a poorly maintained assembly will greatly decrease the life of the vacuum motors and will void the warranty.

If debris builds up on this filter, it will reduce the vacuum air flow and may cause a significant decrease in the rate of water recovery. If debris prevents the float from moving or seating inside the assembly, it may not stop the airflow when the tank fill with water, and the water will be sucked into the vacuum and blown out the exhaust. **Always use defoamer to prevent foam or moisture from entering vacuums.**

To clean:

1. Twist to loosen and pull the assembly off of the stand pipe.
2. Pull fibers and lint off and rinse with clean water.
3. Push the assembly back onto the stand pipe and replace the recovery tank lid.

## **RINSE OUT RECOVERY TANK:**

Clean out the tank on a regular basis to extend the life of vacuum & recovery components as well as keep the tank smelling better.

1. Remove the recovery tank lid.
2. Use a hose to rinse the dirt and debris out of the recovery tank.
3. Spray the tank with a deodorizer or disinfectant.
4. Replace the recovery tank lid.
5. Dispose of the dirty water and debris.

## **FLUSH SOLUTION TANK AND PUMP:**

1. Pour one gallon of clean water into the solution tank. Slosh the water around in the tank to clean tank and pour water out and dispose of the dirty water.
2. Pour another gallon of clean water into the tank.
3. With Cord plugged in, connect the solution hose& tool to the solution outlet male quick connect.
4. Direct the tool into a bucket or sink and turn the solution pump ON.
5. Spray the tool into the bucket or sink until most of the water has been pumped out of the solution tank
6. Turn the pump OFF and disconnect the solution hose and tool.
7. Drain the remaining water out of the solution tank and dispose of the dirty water.

If there is a heavy chemical build-up in the machine, hoses, or tools, a mild acid can be added to the rinse water in the previous procedure.

## **CLEAN PUMP INLET FILTER**

A restricted Pump Inlet Filter can prevent the solution pump from providing adequate pressure for cleaning.

- Remove the stainless steel filter screen and clean as needed.
- Do not operate the machine without the pump inlet filter in place.
- Replace filter, hose & barb as needed.

## Descaling Heater – MA51H Only:

1. Pour one gallon of descaling solution into the solution tank. For light scale build-up a mild acid solution may be sufficient. Heavier build-up may require a stronger descaling solution.
2. With Cord plugged in, connect the solution hose& tool to the solution outlet male quick connect.
3. Direct the tool into a bucket or sink and turn the Solution Pump ON. Once you have solution at the tool, turn the Heater ON and turn the Solution Pump OFF. Wait about 5-10 minutes and turn the Heater OFF and turn the Solution Pump ON.
4. Spray the tool into the bucket or sink until most of the descaling solution has been pumped out of the solution tank. Turn the pump OFF and disconnect the solution hose and tool.
5. Repeat the descaling process as needed to remove heavier scale build-up. Drain the remaining descaling solution out of the solution tank. Rinse the solution tank, pump & heater with clean water and dispose of the descaling solution and dirty water.

## Removing Base to Access Heater – MA51H Only

To remove the base of the MA51H to access the heater, use a 3/16" Allen wrench to remove the two screws holding the base to the solution tank. One screw is located on each side of the Power X Pro Spot Extractor.

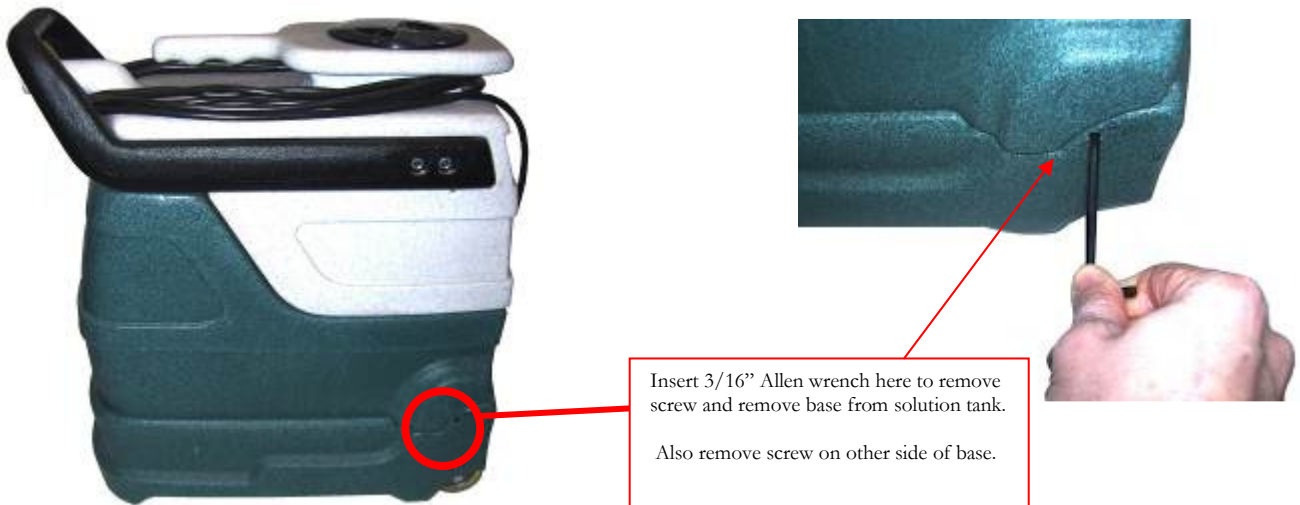

## Storage Prep and Freeze Protection Procedures:

Your Power X Pro Spot Extractor must be protected from freezing. Freezing can cause serious damage to the pump, pump-out, auto-fill float valve, and any other component containing water. If the Power X Pro Spot Extractor is transported or stored in freezing temperatures, the following procedures should be performed.

1. In a separate container mix 1 pint of water with 1 pint of automotive radiator anti-freeze. (Ethylene glycol type). Mix well and pour into the solution tank.
2. Connect the solution hose to the solution outlet male quick connect and hold the tool over a bucket.
3. Turn the solution pump switch to the ON position. Spray the tool into the bucket until you see the anti-freeze solution coming out of the jet into the bucket.
4. Turn the solution pump off.
5. Drain the remaining anti-freeze solution from the solution tank and the machine is ready for storage.

## RETURNING THE POWER X PRO SPOT EXTRACTOR TO SERVICE AFTER STORAGE OR FREEZE PROTECTION:

To return the Power X Pro Spot Extractor to service, the anti-freeze must be flushed from the machine. Flush the anti-freeze out of the machine by repeating the procedure above using one quart of clean water in place of the anti-freeze solution.

## Parts

*Replacement parts available for repair of your Power X Pro Spot Extractor:*

### **Power X Spotter Pump – AP30**

SOLUTION INLET  
1/8" FPT

SOLUTION OUTLET  
1/8" FPT



### **Power X Spotter Vacuum Motor – AV06**



Item #	MA51 Component Description	Qty Needed
NM5090-ST	Solution Tank	1
NM5090-RT	Recovery Tank	1
10-0383	6/32 x ¼ Phil Pan Blk Screw (Latch & Switch Plate)	8* / 6**
10-0400-D	Latch	1
10-0412	C Channel For Spotter	2
10-0414	Rivet For Spotter Handle	4
10-0384	.125 Thick Nylon Washer	4
10-0385	.06 Thick Nylon Washer	4
NM5032	Flat Washer #8 SAE	5
10-0216	Allen Head Screw	4
10-0379	8-32 x 3/8" Screw	4
10-0405	1½" PVC SCH40 Slip Thread	1
10-0302-A	Gasket Tank Lid	1
10-0416-A	ABS Stand Pipe Black 1½"	1
10-0304	Spotter Cap And Float Assembly	1
10-0302	Tank Hatch & Rim Assembly Only	1
10-0419	Screw For Spotter Hatch	6
SP-3-H-BLK	Handle - Black	1
NM5090-HANDLE	Handle Assembly (Includes hardware)	1
10-0406	Nylon Barb 90 1/8 NPT ¼	2
PP11-800091	1/8" NPT Bulkhead Fitting (80-0017-2)	1
BR130	Nipple Reducing 1/4" x 1/8" Hex	1**
BR070	Nipple 1/8" Hex	1*
AH102B	Quick Connect 1/4" Male	1**
PAF03	Quick Connect 1/8" Male	1*
10-0434	Threaded Hose for Spotter	2.5
NA0839	Barb Nylon Straight 1/8 NPT X	4
NA0840	1/8" Strainer for Spotter	1
AP30	Pump For Spotter	1
10-0301	L Bracket For Spotter	1
10-0435	Oetiker Clamp	5
10-0303	Roller Blade Wheel	2
10-0387	5/16 x 1" Socket Head Bolt (For Wheels)	2
10-0022	Screw	1
10-0017	Deflector Screw	1
10-1028	Bottom Base Plate for Spotter	1
10-0492	Screw for Bottom Plate	4* / 2**
10-0014	Motor Mount Screws	2
10-0380	Vac Motor Plate Screw 10-32 x 3/8"	2
10-1024	Vac Motor Mounting Plate	1
AV06	Vacuum Motor	1
10-0386	Stamped Motor Screen	1
PS10-1030	Spotter Motor Gasket	1
10-0027-A	Strain Relief Nut For Spotter	1
10-1025	Back Switch Plate (no heater)	1
10-0027	Pigtail Strain Relief Spotter	1
10-0448-B	20 Ft. Spotter/Air Mover Cord	1
PDR101	On/Off Rocker Switch	1* / 2**
10-0400-C	Latch Keeper 10-0400-C	1
NM4061	Screw 10-32 x 1/2" BH SOC SS	1
NM4081	NUT 10-32 NYLOCK SS	1

\* For older style units / \*\* For newer style units

# MA51

1/4" NYLON BARB X 1/8" MPT  
NA0839

1/8" HEX NIPPLE  
BR070

PUMP  
AP30

OETIKER HOSE CLAMP  
10-0435

Serial # 35P-3144  
Model 50-1000-BP  
Amps 6.4  
Volts 120 Hertz 60  
D.O.M. 8/19/13

1/4" ID THREADED HOSE  
10-0434

SCREW VAC MOTOR MOUNT (QTY 2)  
10-0014

1/4" NYLON BARB/ ELBOW - 1/8" MPT  
10-0406

VACUUM MOTOR  
AV06

WHEELS (QTY 2)  
10-0303

SCREW 5/16 X 1" SOC HD  
FOR WHEEL MOUNT  
10-0387 (QTY 2)

PLATE VAC MOTOR MOUNT  
10-1024

SCREW VAC MOUNT PLATE (QTY 2)  
10-0380

VACUUM GASKET  
PS10-1030

VACUUM SCREEN  
10-0386

VACUUM MOTOR  
AV06

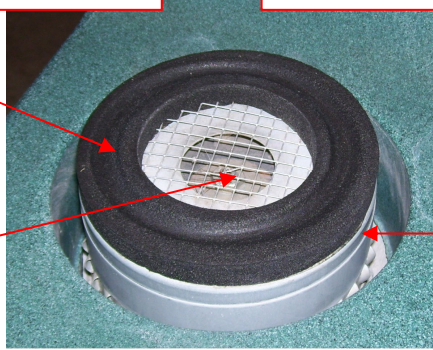
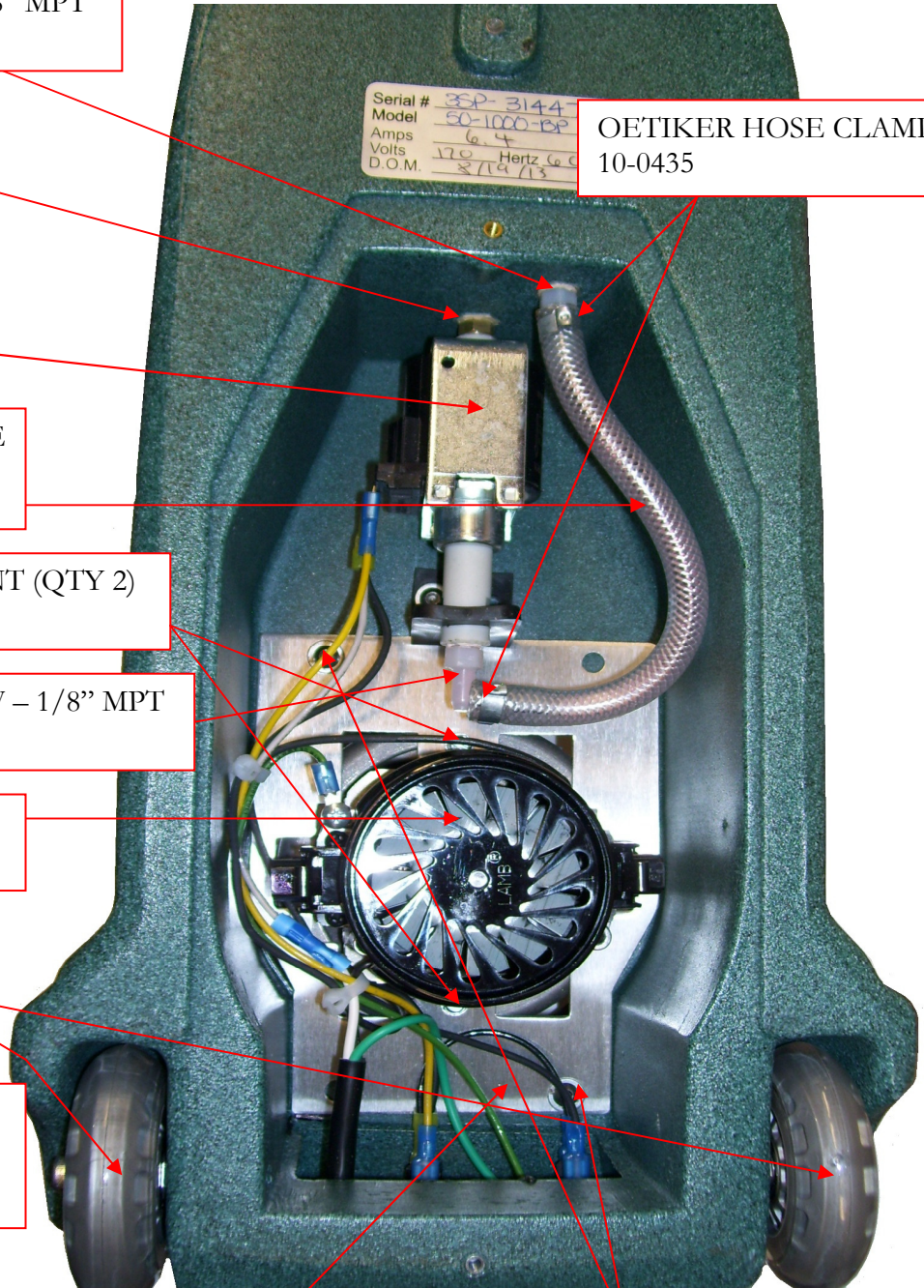

# MA51

1/4" NYLON BARB X 1/8" MPT  
NA0839

OETIKER HOSE CLAMP  
10-0435

ACORN STRAINER  
NA0840

1/4" NYLON BARB/ ELBOW 1/8" MPT  
10-0406

1/4" ID HOSE  
10-0434

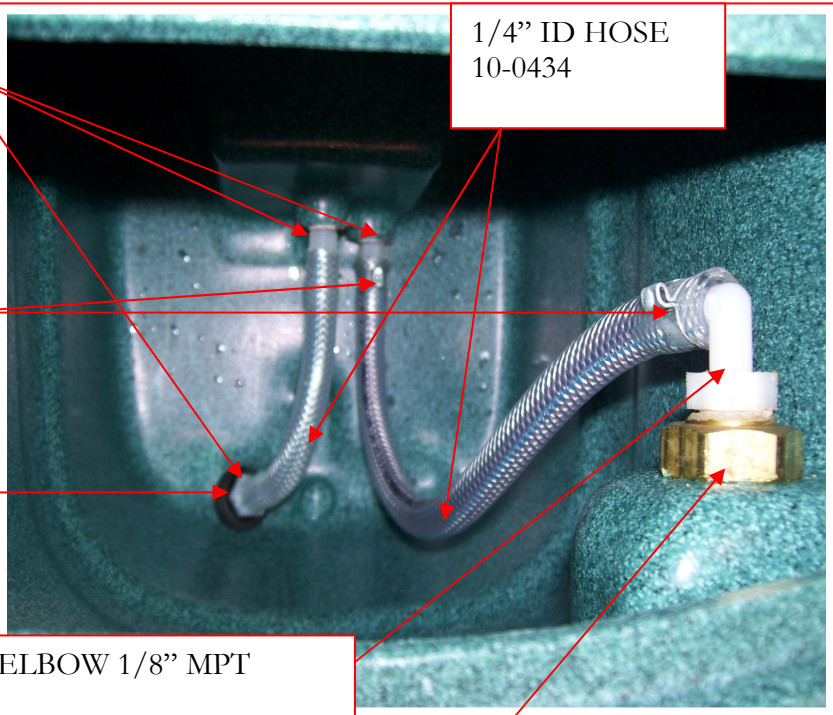

1/8" NPT BULKHEAD FITTING  
PP11-800091

1/4" MALE QUICK CONNECT  
AH102B

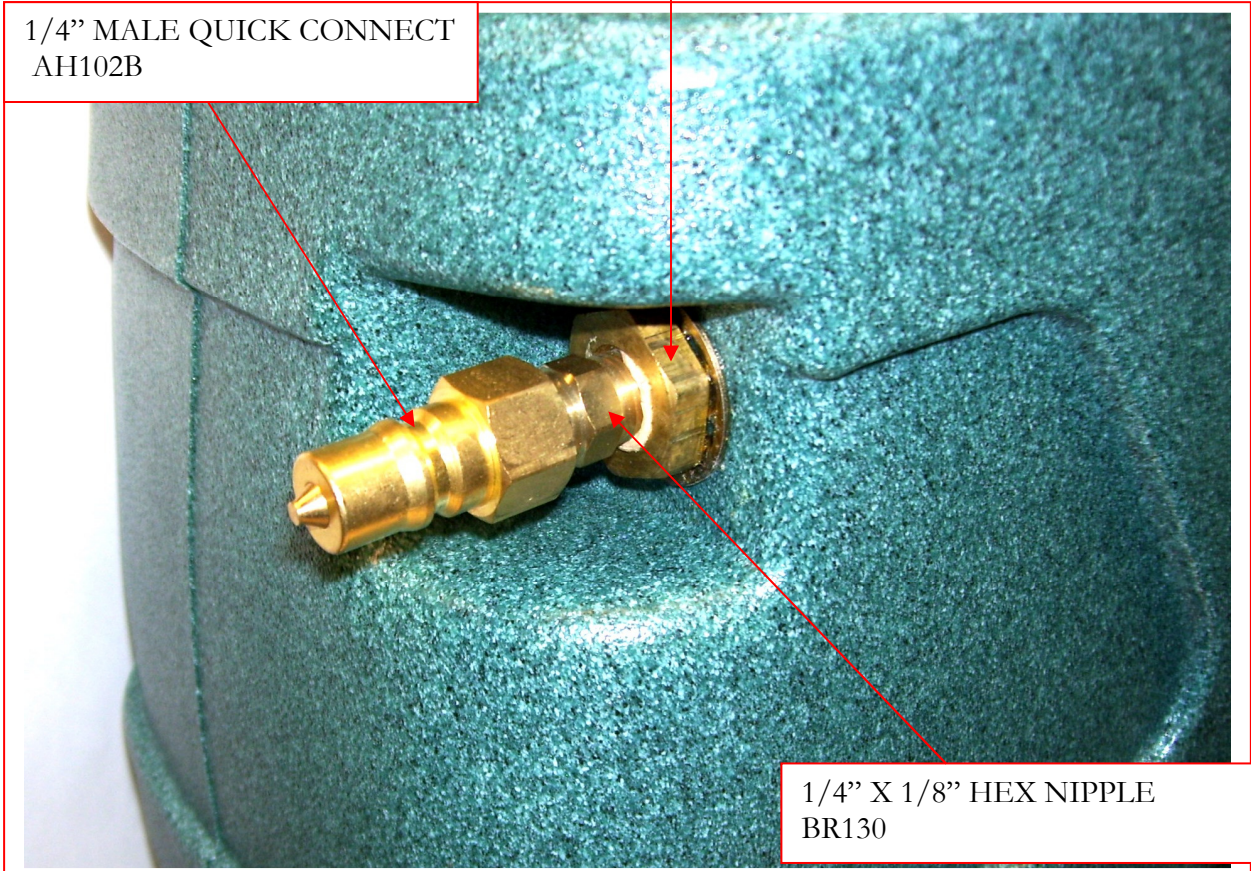

1/4" X 1/8" HEX NIPPLE  
BR130



# MA51

VACUUM FILTER  
10-0431



SPOTTER HATCH COVER  
BOTTOM VIEW



SPOTTER HATCH & COVER  
10-0302  
GASKET – 10-0302-A  
SCREWS – 10-0419 (QTY 6)

SPOTTER HANDLE ASSEMBLY  
NM5090-HANDLE

HANDLE SLIDE ASSEMBLY  
50-0001A



SPOTTER COVER & FLOAT  
10-0304

RECOVERY TANK  
NM5090-RT

SOLUTION TANK  
NM5090-ST

SOLUTION TANK  
NM5090-ST

SCREW FOR BASE PLATE - 10-0482  
FLAT WASHER – NM5032  
(Old style -4) (New Style – 2)

# MA51

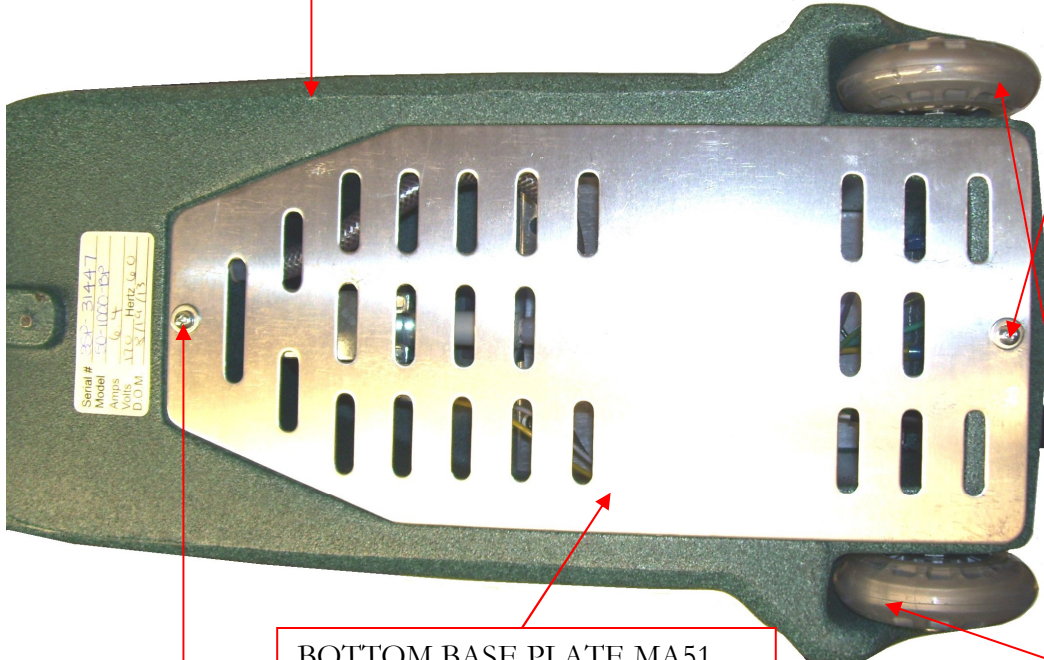

BOTTOM BASE PLATE MA51  
10-1028

WHEELS (QTY 2)  
10-0303  
SCREWS – 10-0387

SCREW FOR BASE PLATE - 10-0482  
FLAT WASHER – NM5032  
(Old style -4) (New Style – 2)

LATCH  
10-0400D  
SCREWS  
10-0383 (QTY)

LATCH KEEPER  
10-0400C  
SCREWS  
10-0383 (QTY 2)

RECOVERY TANK  
NM5090-RT

SOLUTION TANK  
NM5090-ST

MA51 BACK / SWITCH PLATE  
10-1025

SWITCH  
PDRI01

GROUND SCREW  
NM4061  
NUT – NM4081

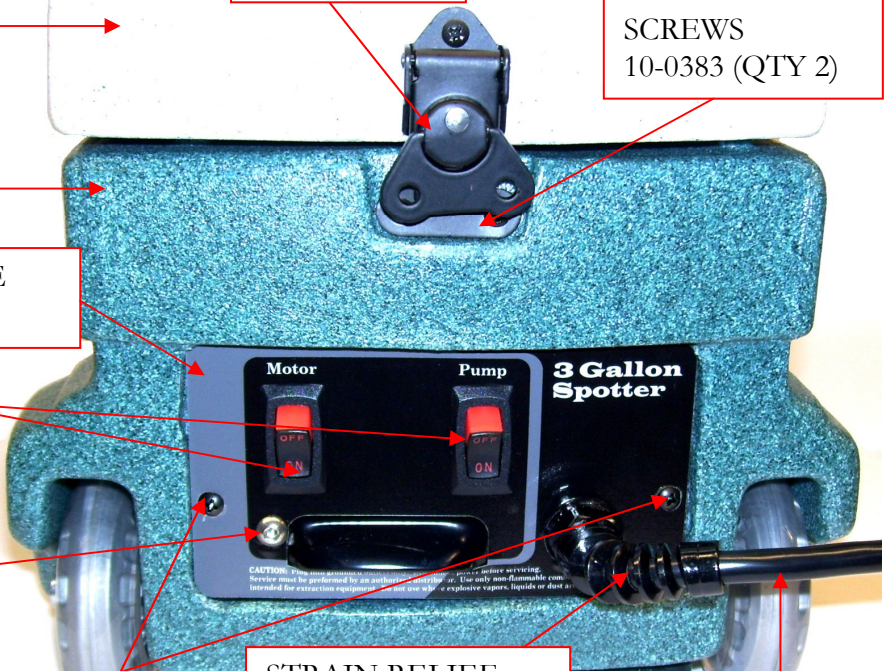

SCREW 6-32 X 1/4"  
10-0383 - (Old style -4) (New Style – 2)

STRAIN RELIEF  
10-0027  
NUT – 10-0027-A

POWER CORD  
10-0448-B

<b>Item #</b>	<b>MA51H Component Description</b>	<b>Qty Needed</b>
NM5090-ST	Solution Tank	1
NM5090-RT	Recovery Tank	1
10-0383	6/32 x ¼ Phil Pan Blk Screw (Latch & Switch Plate)	6
10-0400-D	Latch	1
10-0412	C Channel For Spotter	2
10-0414	Rivet For Spotter Handle	4
10-0384	.125 Thick Nylon Washer	4
10-0385	.06 Thick Nylon Washer	4
NM5032	Flat Washer #8 SAE	5
10-0216	Allen Head Screw	4
10-0379	8-32 x 3/8" Screw	4
10-0405	1½" PVC SCH40 Slip Thread	1
10-0302-A	Gasket Tank Hatch	1
10-0416-A	ABS Stand Pipe Black 1½"	1
10-0304	Spotter Cap And Float Assembly	1
10-0302	Tank Hatch & Rim Assembly Only	1
10-0419	Screw For Spotter Hatch	6
SP-3-HS-GRNGRAN	Base Spotter Skirt w/ Heat	1
10-0831	S/R Bracket	1
10-0832	S/R Strap Bolts	2
AP30	Pump For Spotter	1
BR070	Nipple 1/8" Hex Brass	1
PSA100901	Pressure Relief Valve 175psi	1
BR220	Brass Plug 1/8"	1
NM5087	Bulkhead Fitting 1/4" Brass	2
BR020	Barb 3/8" x 1/4" MPT Brass	4
PH07	Hose Clamp	6
10-0843	Hose 3/8" ID Black LP	1
10-0434	Threaded Hose for Spotter	1
NA0839	Barb Nylon Straight 1/8 NPT X 1/4" Barb	4
NA0840	1/8" Strainer for Spotter	1
10-0301	L Bracket For Spotter	1
10-0828	90 Deg Brass Elbow 1/8" MPT	1
10-0022	Screw	3
10-0017	Deflector Screw	1
PA076	Female Spade Connector Insulated – Blue	10
T-WPUR	Purple Wire	
BR282	Elbow 90 Deg 1/4" Street M-F	1
BR252	Tee 1/4" Street M-F-F	1
10-0843	Hose 3/8" ID Black LP – Sold per inch	24
BR292	Elbow 90 Deg 1/4" F-F	1
NM5069	Check Valve 1/4" MPT	1
80-0014	Elbow 90 Deg 1/4" FPT x 3/8" barb	1
BR082	1/4" Close Nipple Brass	1
AH102B	1/4" Male Quick Connect	1
PSA101500B	Heater – Element Only	1
10-0814	Temperature Switch Auto Reset	1
10-0814-B	Temperature Switch Manual Reset	1
10-0907	Strain Relief for Heater	1

<b>Item #</b>	<b>MA51H Component Description</b>	<b>Qty Needed</b>
10-0906	Heater Box Only	1
10-0900	Heater Body Only	1
10-0801-G	Insulation for Heater Box	1
PSA100910	Heater Assembly Complete with all Fittings & Temperature Switches	1
PSA001	High Pressure – High Temperature Hose Assembly	1
SP-3-H-BLK	Handle - Black	1
NM5090-HANDLE	Handle Assembly (Includes hardware)	1
10-0387	5/16 x 1" Socket Head Bolt (For Wheels)	2
10-0303	Roller Blade Wheel	2
10-0822	Exhaust Grate	2
10-0419-A	Screw For Exhaust Grate	2
10-0014	Motor Screws	2
10-0380	Screw 10-32 x 3/8"	2
10-1024	Vac Motor Mounting Plate	1
AV06	Vacuum Motor	1
10-0386	Stamped Motor Screen	1
PS10-1030	Spotter Motor Gasket	1
10-0027-A	Strain Relief Nut For Spotter	1
T-WBLA	Black Wire	
10-0027	Pigtail Strain Relief Spotter	1
10-0448-B	20 Ft. Spotter/Air Mover Cord	1
PDR101	On/Off Rocker Switch	3
10-1026	Back Switch Plate (with heater)	1
10-0400-C	Latch Keeper 10-0400-C	1
NM4061	Screw 10-32 x 1/2" BH SOC SS	3
NM4255	Washer Flat #10 SS	2
NM4081	NUT 10-32 NYLOCK SS	1

# MA51H

VACUUM FILTER  
10-0431



SPOTTER HATCH COVER  
BOTTOM VIEW



SPOTTER HATCH & COVER  
10-0302  
GASKET – 10-0302-A  
SCREWS – 10-0419 (QTY 6)

SPOTTER HANDLE ASSEMBLY  
NM5090-HANDLE  
HANDLE SLIDE ASSEMBLY  
50-0001A



SOLUTION TANK  
NM5090-ST



SPOTTER COVER & FLOAT  
10-0304

RECOVERY TANK  
NM5090-RT

SPOTTER BASE W/ HEAT  
SP-3-HS-GRNGRAN

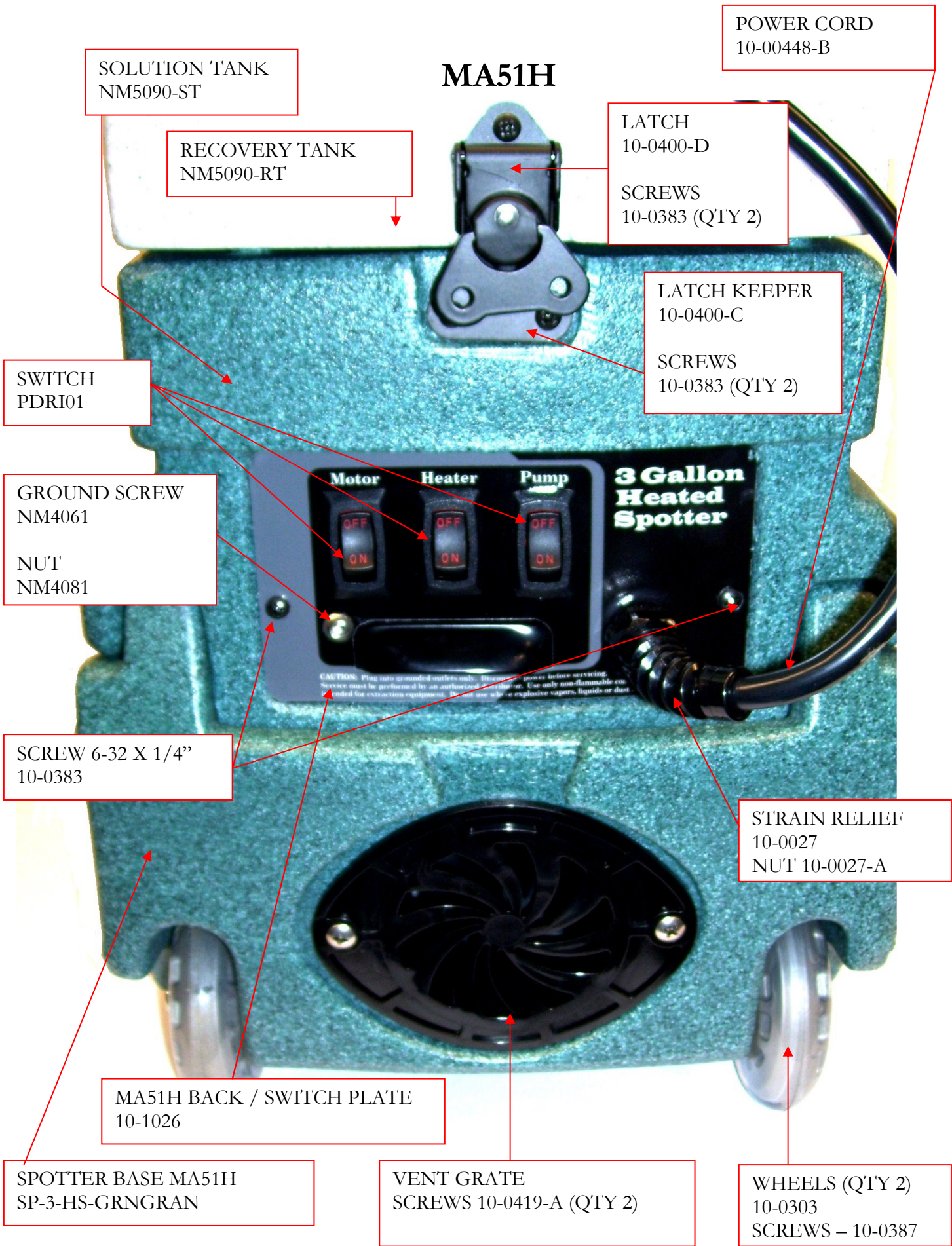

SOLUTION TANK  
NM5090-ST

RECOVERY TANK  
NM5090-RT

**MA51H**

POWER CORD  
10-00448-B

LATCH  
10-0400-D  
SCREWS  
10-0383 (QTY 2)

LATCH KEEPER  
10-0400-C  
SCREWS  
10-0383 (QTY 2)

SWITCH  
PDRI01

GROUND SCREW  
NM4061  
NUT  
NM4081

**3 Gallon Heated Spotter**

Motor Heater Pump

OFF ON OFF ON OFF ON

CAUTION: Plug into grounded outlets only. Disconnect power before servicing. Service must be performed by an authorized technician. Use only non-flammable cleaning agents for extraction equipment. Do not use above explosive vapors, liquids or dust.

SCREW 6-32 X 1/4"  
10-0383

STRAIN RELIEF  
10-0027  
NUT 10-0027-A

MA51H BACK / SWITCH PLATE  
10-1026

SPOTTER BASE MA51H  
SP-3-HS-GRNGRAN

VENT GRATE  
SCREWS 10-0419-A (QTY 2)

WHEELS (QTY 2)  
10-0303  
SCREWS – 10-0387

# MA51H

SCREW VAC MOTOR MOUNT (QTY 2)  
10-0014

HOSE 3/8" ID HI-TEMP BLACK

PUMP  
AP30

1/8" HEX NIPPLE  
BR070

BARB 3/8" X 1/4" MPT  
BR020

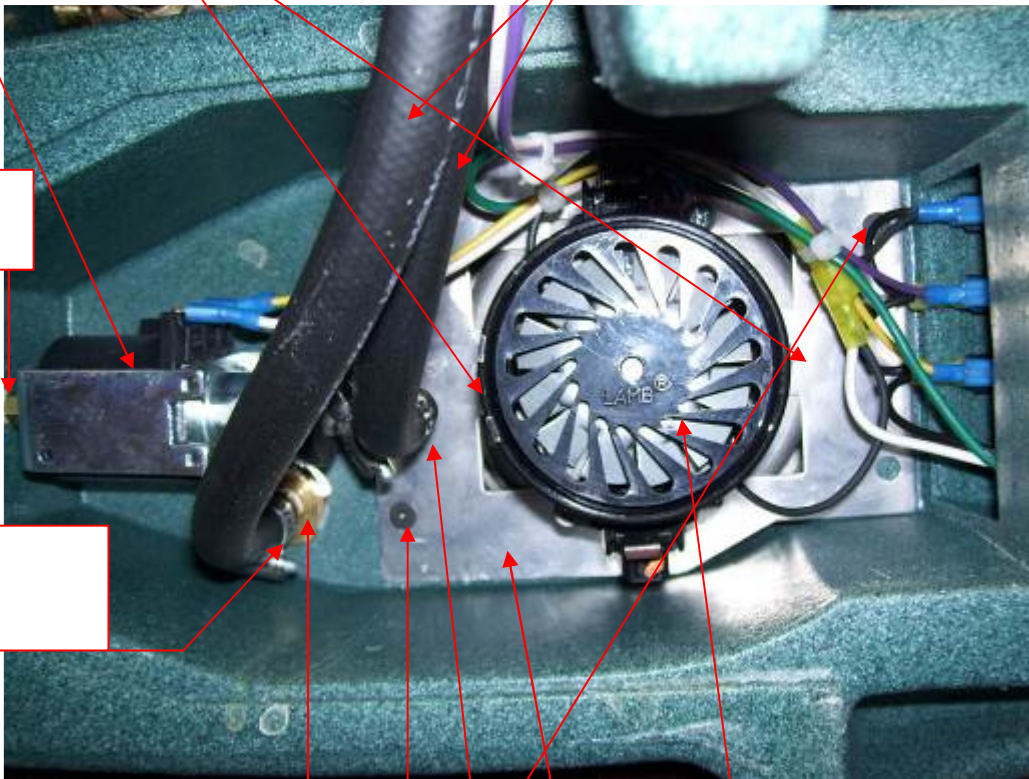

BULKHEAD FITTING 1/4"  
NM5087

VACUUM MOTOR  
AV06

SCREW VAC MOUNT PLATE (QTY 2)  
10-0380

PLATE VAC MOTOR MOUNT

90 DEGREE BRASS ELBOW 3/8" BARB X 1/8" MPT  
10-0828

VACUUM GASKET  
PS10-1030

VACUUM SCREEN  
10-0386

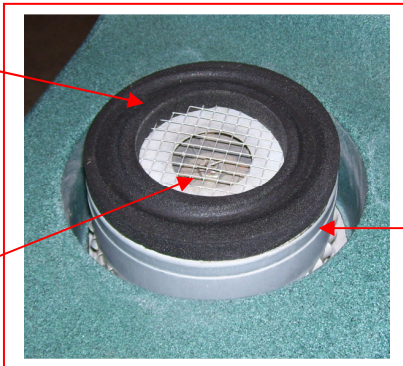

VACUUM MOTOR  
AV06

# MA51H Heater Assembly

Heater is secured to Spotter Base with two screws & Flat Washers:  
 2 - SCREW 10-32 x 1/2" BH SOC SS – NM4061  
 2 – WASHER FLAT #10 SS – NM4255

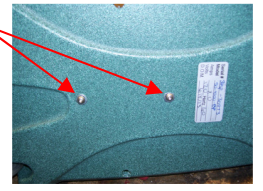

HOSE HP 1/4" ID HI-TEMP BLUE  
 1/4" JIC FITTINGS – PSA001

HOSE LP 3/8" ID HI-TEMP BLACK  
 10-0843 (Sold per inch)

BARB 3/8" X 1/4" MPT  
 BR020

ADAPTER 1/4" MPT X 1/4" T M FLARE  
 BR126

PRESSURE RELIEF VALVE  
 PSA100901

CHECK VALVE 1/4" MPT  
 NM5069

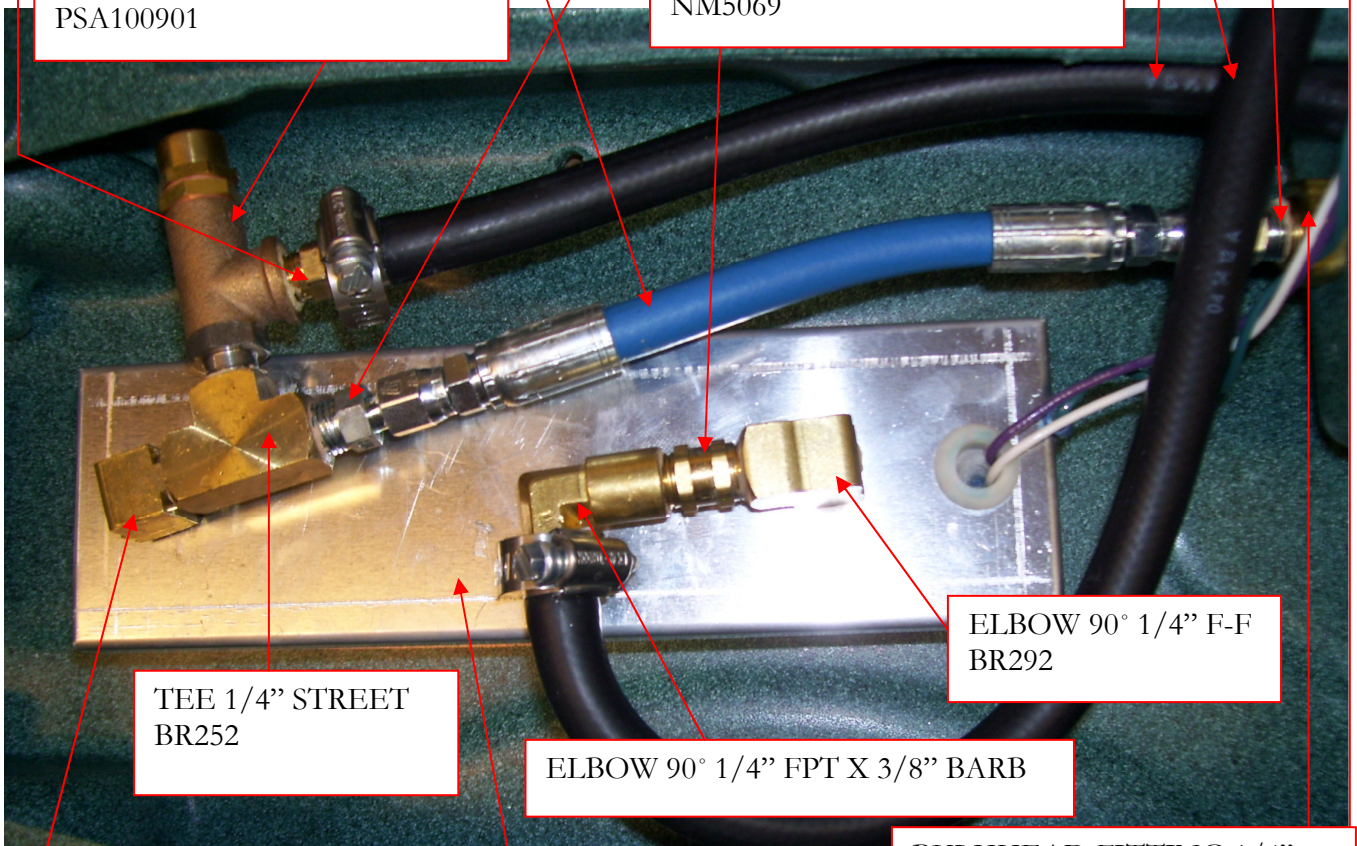

TEE 1/4" STREET  
 BR252

ELBOW 90° 1/4" F-F  
 BR292

ELBOW 90° 1/4" FPT X 3/8" BARB

ELBOW 90° 1/4" STREET  
 BR282

HEATER 600W  
 PSA100910  
 COMPLETE WITH FITTINGS

BULKHEAD FITTING 1/4"  
 NM5087

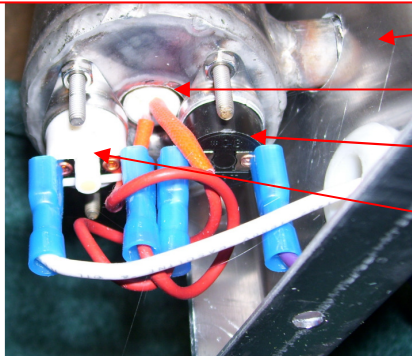

HEATER OUTER SHELL ONLY – PSA100900

HEATER ELEMENT ONLY – PSA101500B

TEMPERATURE SWITCH AUTO RESET  
 10-0814

TEMPERATURE SWITCH MANUAL RESET  
 10-0814-B



# MA51H

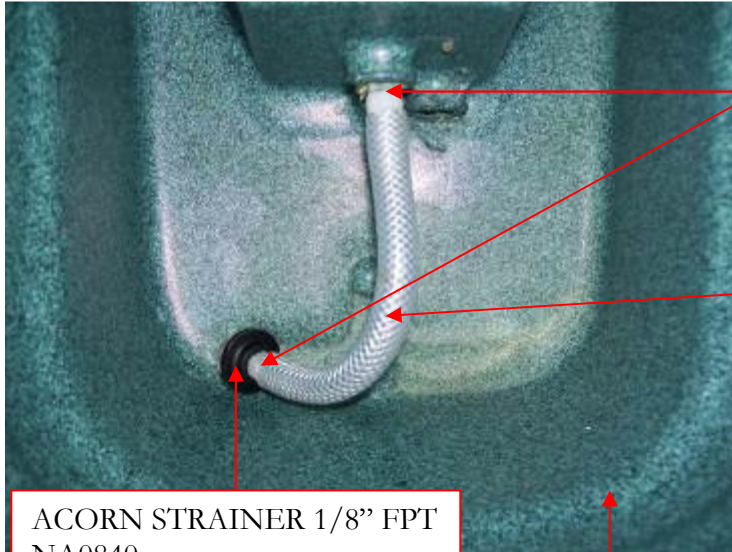

BARB 1/4" X 1/8" MPT  
NA0839

1/4" ID HOSE  
10-0434

ACORN STRAINER 1/8" FPT  
NA0840

RECOVERY TANK  
NM5090-RT

SOLUTION TANK  
NM5090-ST



SPOTTER BASE MA51H  
SP-3-HS-GRNGRAN



BULKHEAD FITTING 1/4"  
NM5087

NIPPLE 1/4" HEX  
BR072

1/4" MALE QUICK CONNECT  
AH102B

## AW55H HOSE & TOOL ASSEMBLY

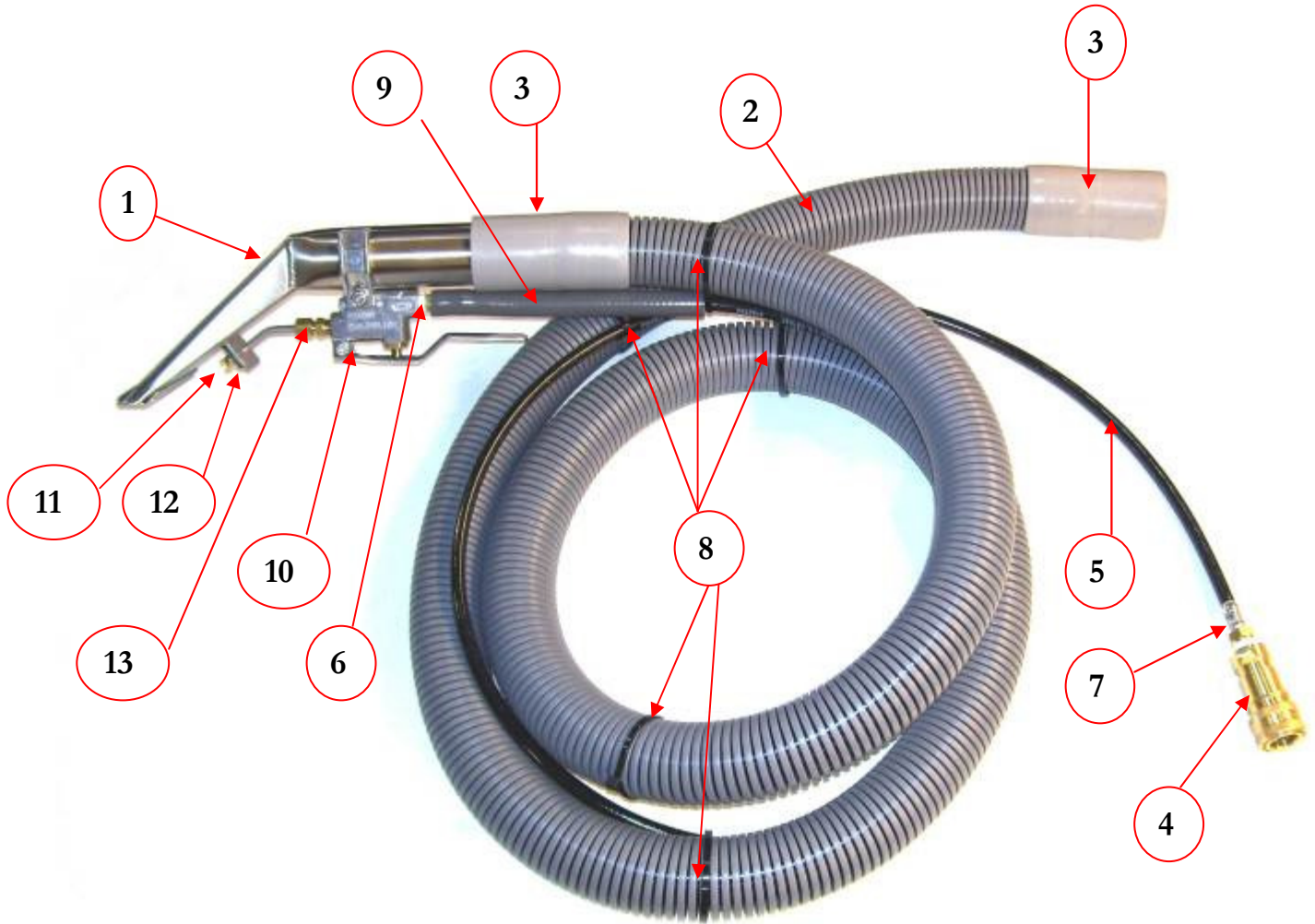

	ITEM#	Description	QTY
1	PA205	3.5" SS Upholstery Tool	1
2	AH35	1-1/4" Gray Vacuum Hose (Sold per foot)	7'
3	PP08-805088	1-1/4" Hose Cuff	2
4	AH101B	1/4" QD Female	1
5	NA40A	3/16" HP Black Solution Hose (Sold per Inch)	96"
6	AH01	1/8" Hose End for 3/16" hose	1
7	AH02	1/4" Hose End for 3/16" hose	1
8	100003	Wire Tie Black 7"	5
9	AH90	3/8" LP Gray Solution Hose (Sold per foot)	0.5
10	PMV124V5	Solution Valve with lever & mounting bracket	1
11	PMF8002	Tee Jet for hand tool 8002	1
12	PMF011	Retaining Plate for jet on hand tool	1
13	BR304	Compression fitting 1/8" MPT	1
NS	PMV124V5B	Valve Repair Kit	1

## Limited Warranty

Your Power X Pro Spot Extractor is designed to give you years of reliable service. If a problem should arise use the troubleshooting section in the operation manual to diagnose and correct the problem if possible.

If you are unable to determine the cause or solution to the problem contact your distributor or Hydro-Force for assistance.

Hydro-Force warrants the roto-molded tanks and base of the Power X Pro Spot Extractor to be free from defects in material or workmanship for five years from the date of purchase.

All other components of the Power X Pro Spot Extractor are warranted to be free of defects in material and workmanship for one year from the date of purchase.

During the warranty period, Hydro-Force will, at its option repair or replace components which prove to be defective. This warranty does not provide for replacement of complete units due to defective components. Any costs for transportation or related service labor are not covered in this warranty. Replacement parts are warranted only for the remainder of the original warranty period.

This warranty shall not apply to defects resulting from improper operation, lack of maintenance, unauthorized modification, chemical incompatibility, misuse, abuse or exposure to freezing temperature conditions. It does not cover normal wear items such as o-rings, valve seals, pump seals, hoses, jets, cords, batteries, or other items which require replacement as a result of ordinary usage.

To obtain warranty service for the Power X Pro Spot Extractor, contact your distributor or Hydro-Force. If the spotter must be returned to Hydro-Force or an authorized service center, the purchaser shall prepay shipping charges for products returned for warranty service. No returned items will be accepted by Hydro-Force without prior authorization. All returns must have a return authorization number, issued by Hydro-Force, clearly marked on the exterior of the package.

Hydro-Force makes no other warranty either expressed or implied with respect to this product.

The remedies provided herein are the purchaser's sole and exclusive remedies. In no event shall Hydro-Force be liable for any direct, indirect, special, incidental or consequential damages.

This warranty gives you specific legal rights. You may also have other rights which vary from jurisdiction to jurisdiction.